

8

PERFILES DE ALUMINIO

PERFILES PARA LATERALES ABATIBLES



Tabla central 100 (23514)
005 020 02095 (L=5,1 m)
005 020 02088 (L=6 m)
005 020 02096 (L=6,4 m)



Tabla central 150 (23513)
005 020 02173 (L=5,1 m)
005 020 02087 (L=6 m)

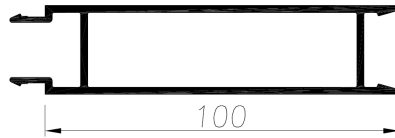

Tabla central 180 (21854)
005 020 01153 (L=5,1 m)
005 020 01081 (L=6 m)

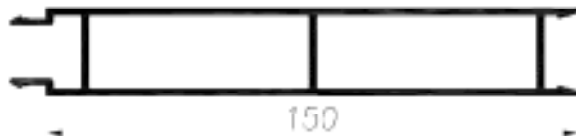

Tabla central 200 (22164)
005 020 01360 (L=5,1 m)
005 020 01148 (L=6 m)
005 020 01149 (L=6,4 m)

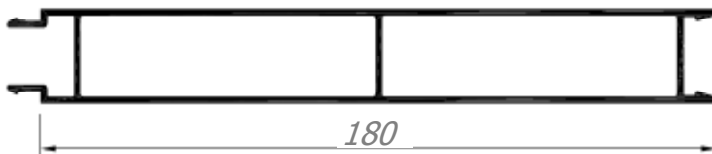

Tabla de rebaje 150 (12924)
005 020 0677 (L=6,4 m)

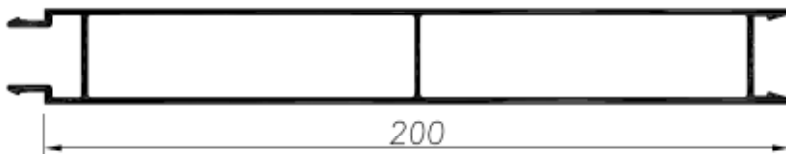

Tabla de rebaje 200 (22162)
005 020 01411 (L=5,1 m)
005 020 01162 (L=6 m)
005 020 01271 (L=6,4 m)

NOTA: Todos los perfiles para laterales son anodizados

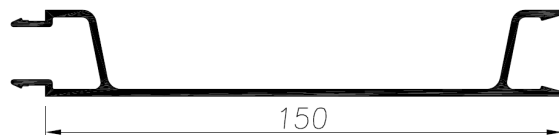
PERFILES PARA LATERALES ABATIBLES



Tabla terminación 100 (23511)

005 020 02164 (L=5,1 m)

005 020 02086 (L=6,4 m)



Tabla terminación 200 (13307)

005 020 05246 (L=5,1 m)

005 020 01202 (L=5,3 m)

005 020 0674 (L=6,4 m)

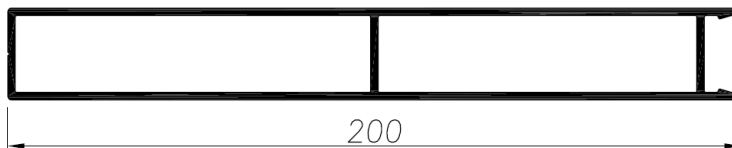

Tabla terminación 215 (22163)

005 020 01410 (L=5,1 m)

005 020 01146 (L=6 m)

005 020 01147 (L=6,4 m)

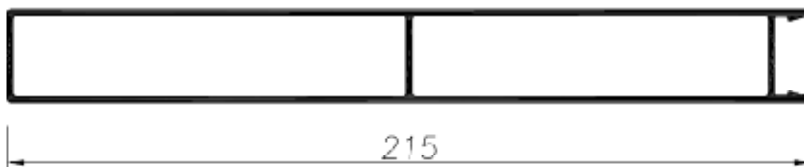

Tabla de bisagra de 200 (22165)

005 020 01410 (L=5,1 m)

005 020 01146 (L=6 m)

005 020 01147 (L=6,4 m)



Tabla de 200 con ala (12923)

005 020 00710 (L=5,1 m)

005 020 0679 (L=6,4 m)

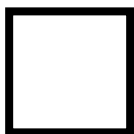

Perfil tapa huecos de 23 x 23 mm (20217)

005 020 01787 (L=6 m)



Perfil tapa huecos de 22 x 30,5 mm (13359)

005 020 0660 (L=6 m)

NOTA: Todos los perfiles para laterales son anodizados

PERFILES PARA LATERALES ABATIBLES

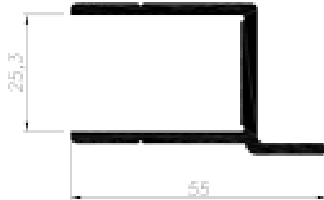

U Ala larga abultada (12926)
005 020 0673 (L=5,1 m)

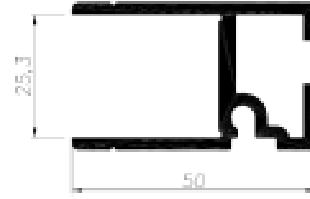

Borde Kinnegrip (12929)
005 020 0657 (L=5,1 m)

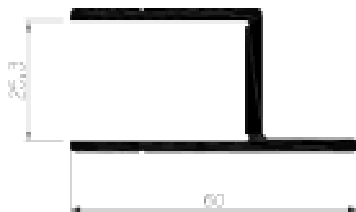

U Ala plana (12925)
005 020 0676 (L=5,1 m)

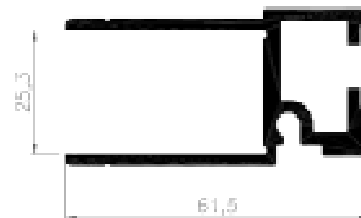

Borde para Kinnegrip K20 (16722)
005 020 0662 (L=5,7 m)

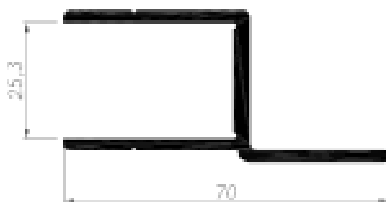

U Ala larga (13235)
005 020 0622 (L=6,2 m)



Borde para Kinnegrip K20 especial (18159)
005 020 0798 (L=6,2 m)



U para remonta (18586)
005 020 0704 (L=6,2 m)



U sencilla de 25x40 mm (14285)
005 020 0619 (L=6 m)
005 020 0665 (L=6,4 m)

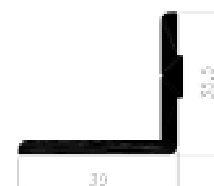

L para lateral (18585)
005 020 0705 (L=6,2 m)

TABLAS APILABLES Y DE BARANDA



Tabla apilable (22694)
005 010 01627 (L=2,6 m)
005 010 01626 (L=3,25 m)
005 010 01628 (L=4 m)



Tabla apilable para amarre de carga
 (20178)
005 010 01255 (L=2,6 m)
005 010 05600 (L=3,25 m)

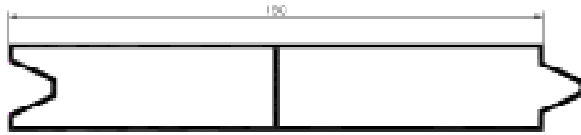

Tabla de baranda (12920)
005 010 01573 (L=5,1 m)
005 010 02016 (L=6,45 m)

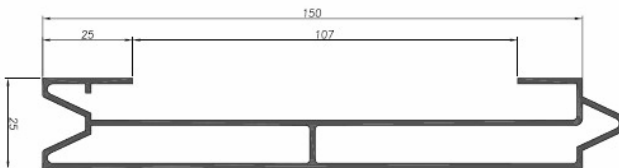

Tabla de separación de carga (18500)
005 010 0624 (L=5 m)

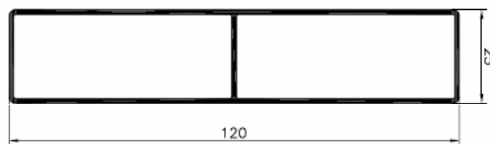

Perfil yugo cartolas (02469)
005 010 0648 (L=6 m)

NOTA: Todos los perfiles son en bruto

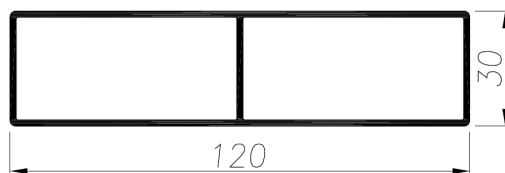
PERFILES PARA PUERTAS

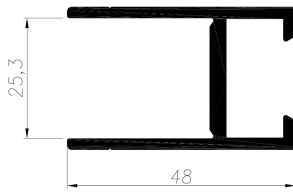

Marco puerta estándar (13082)

005 020 0656 (L=5,2 m)

005 020 0645 (L=5,5 m)

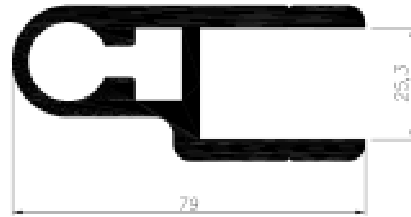

Pilar puerta exterior (16268)

005 020 0614 (L=5,6 m)

005 020 0615 (L=5,8 m)

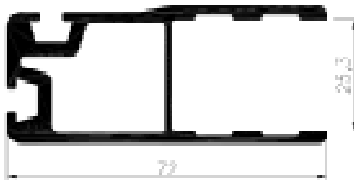

Marco puerta exterior-central (20445)

005 020 05347 (L=5,1 m)

005 020 05346 (L=5,6 m)

005 020 05716 (L=5,8 m)

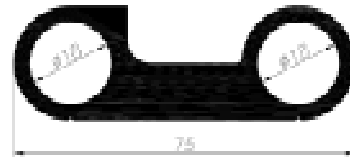

Bisagra de nudo de 75 mm (21737)

005 020 01229 (L=6 m)



Marco puerta exterior-bisagra (20444)

005 020 05344 (L=5,6 m)

005 020 05345 (L=5,8 m)



Bisagra de nudo de 67 mm (16267)

005 020 0613 (L=6 m)

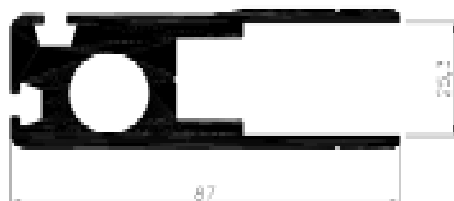

Marco puerta exterior (16269)

005 020 0616 (L=5,1 m)

005 020 0617 (L=5,6 m)

005 020 0618 (L=5,8 m)

PERFILES PARA PUERTAS



Tabla central para eje de falleba (23512)
005 020 02121 (L=6 m)



Perfil puerta telescópica (16266)
005 020 00974 (L=5,8 m)
005 020 0805 (L=6 m)

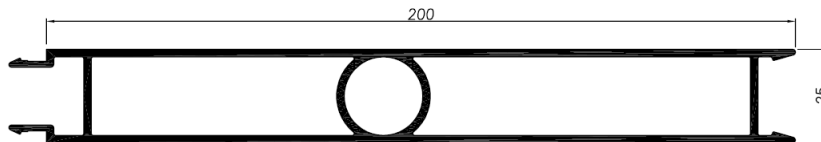
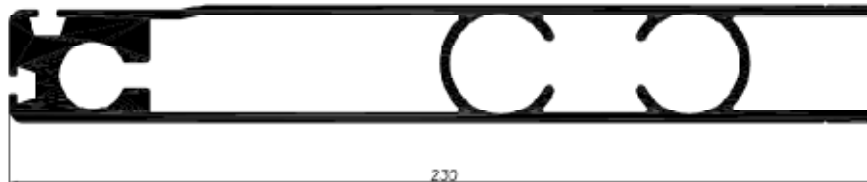
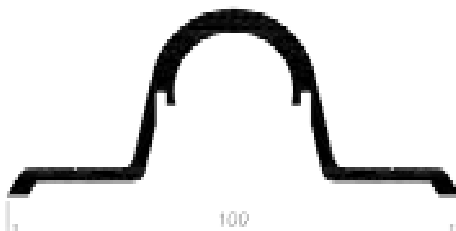

Cubre falleba exterior (14927)
005 020 0642 (L=5 m)
005 020 00726 (L=5 m, lacado blanco)

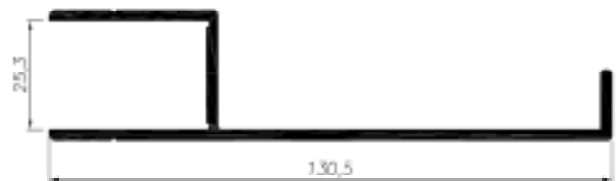

Perfil interior derecho puerta telescópica (17293)
005 020 01722 (L=6 m)



Cubre falleba interior (14926)
005 020 0593 (L=5 m)

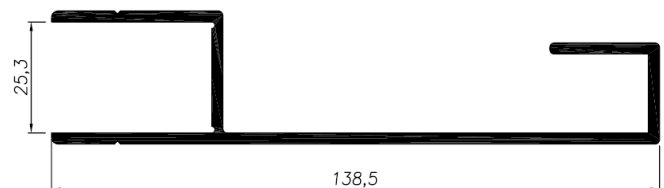

Perfil interior izquierdo puerta telescópica (17292)
005 020 01721 (L=6 m)

PERFILES PARA FRENTES Y PILARES

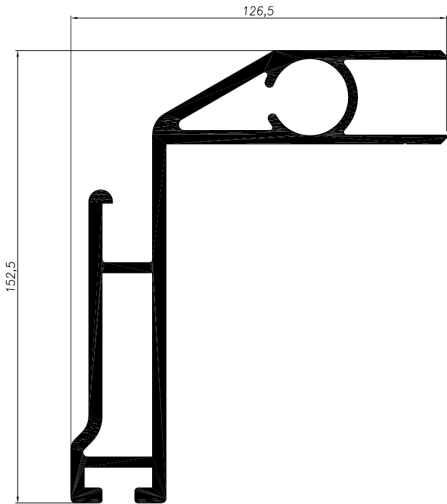

Cantoneira frente (16217)
005 020 0807 (L=6 m)
005 020 01902 (L=5 m)

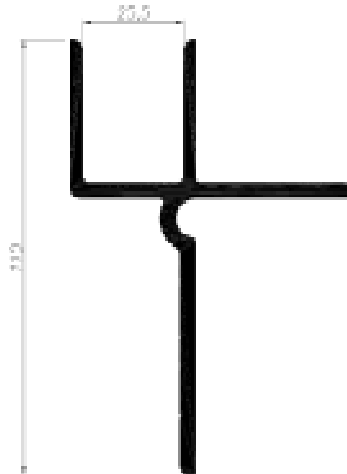

Perfil de banda frente (17274)
005 020 0782 (L=5 m)

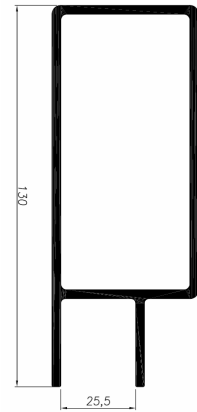

Perfil de cabecero frente (17245)
005 020 0761 (L=5,2 m)



Tabla de cilindro (17948)
005 020 0747 (L=6 m)



Pilar central (15673)
005 020 07444 (L=5,5 m)
005 020 0784 (L=5 m)



Pilar Trasero (20433)
005 020 00732 (L=5,3 m)
005 020 01903 (L=5,8 m)

NOTA: Todos los perfiles para frentes y pilares son anodizados

PERFILES PARA SUELO

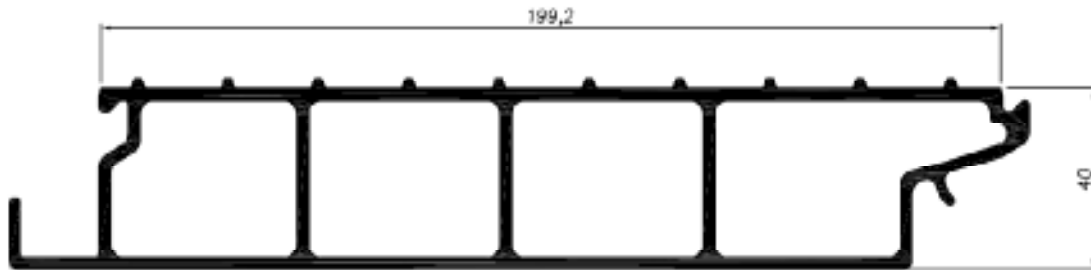

Perfil de suelo ganadero (13666)
005 010 0670 (L=5 m)

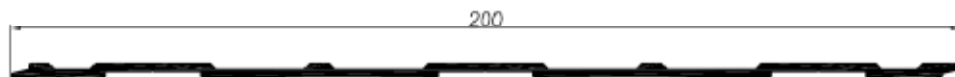

Perfil salva-roces interior recto (13806)
005 010 0651 (L=6,75 m)

PERFILES PARA TECHOS

Tricarriles

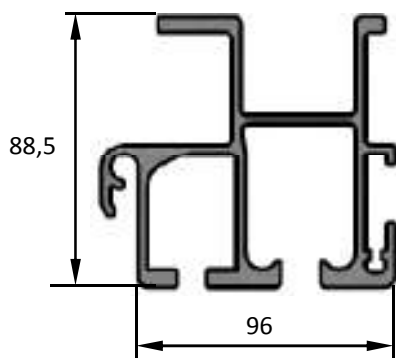

Tricarril T88,5

- 005 040 01463 (L = 4500 mm)
- 005 040 01464 (L = 5500 mm)
- 005 040 01465 (L = 6500 mm)

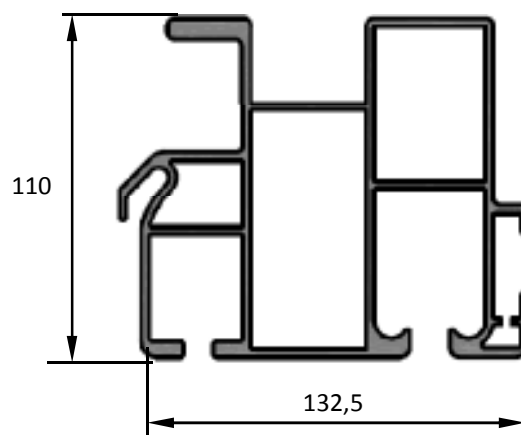

Tricarril T110

- 005 040 01449 (L = 7500 mm)
- 005 040 01450 (L = 8000 mm)
- 005 040 01451 (L = 8500 mm)
- 005 040 01452 (L = 9500 mm)
- 005 040 01453 (L = 10200 mm)
- 005 040 01454 (L = 13600 mm)

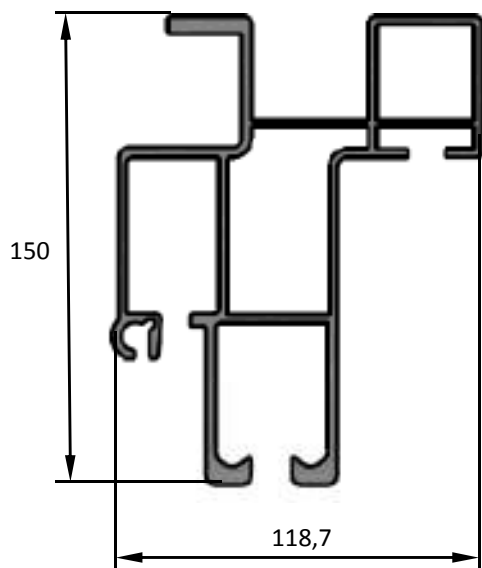

Tricarril T150

- 005 040 01438 (L = 7500 mm)
- 005 040 01439 (L = 8000 mm)
- 005 040 01440 (L = 8500 mm)
- 005 040 01441 (L = 9500 mm)
- 005 040 01442 (L = 13600 mm)

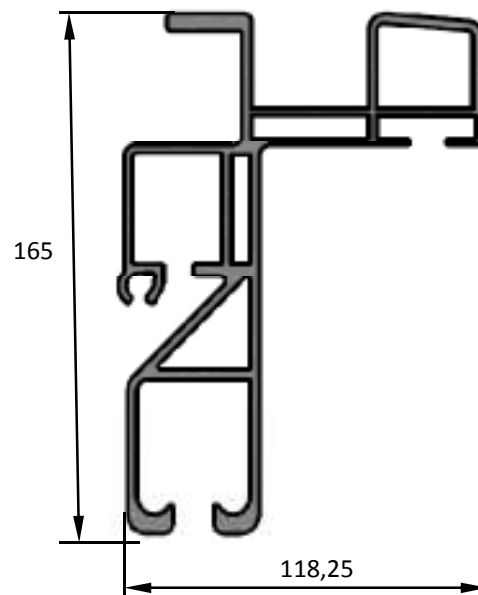

Tricarril T165

- 005 040 01461 (L = 8500 mm)
- 005 040 01462 (L = 13600 mm)

PERFILES PARA TECHOS

Sistemas para adaptar el techo de Auxiliar de Carrocerías

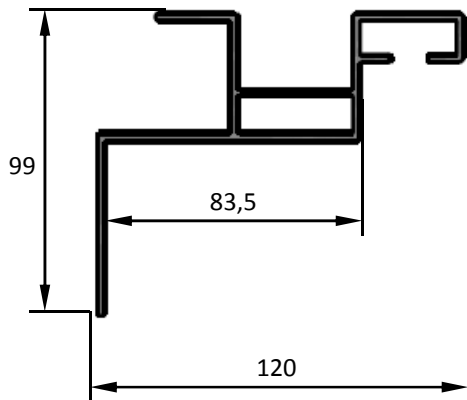

Perfil para adaptar techo de Auxiliar de Carrocerías a cualquier tricarril
005 010 01633 (L = 6800 mm)

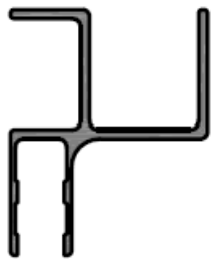

Perfil para adaptar a panel de 15 mm
005 010 05672 (L = 6500 mm)

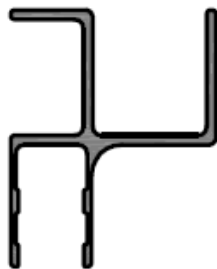

Perfil para adaptar a panel de 20 mm
005 010 05674 (L = 6500 mm)

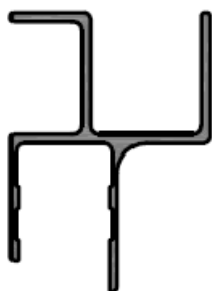

Perfil para adaptar a panel de 30 mm
005 010 05381 (L = 6500 mm)

PERFILES DE TECHO

Adaptación a lateral botellero

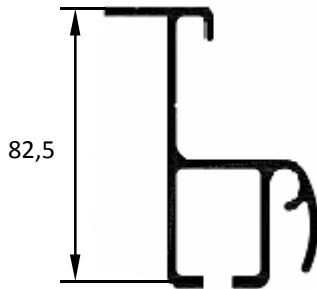

Perfil de lona lateral de 80
005 010 0598 (L=5 m)

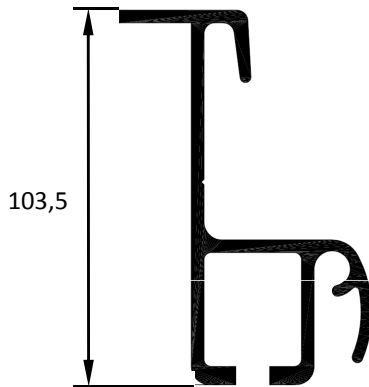

Perfil de lona lateral de 100
005 010 0646 (L=6,75 m)

Recambios para arquillos de techo corredero

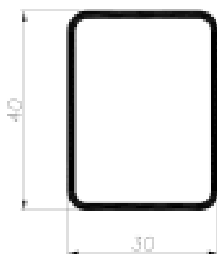

Arquillo de aluminio entre patines
019 020 2036 (L=2,305 m)

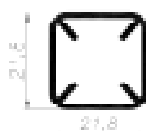

Arquillo eleva-lonas de aluminio
019 020 2034 (L=2,173 m)

PERFILES PARA TENSION DE LONA

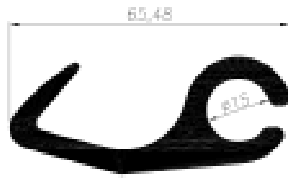

Perfil sujeta-lonas reforzado (14065)
005 010 0649 (L=6 m)

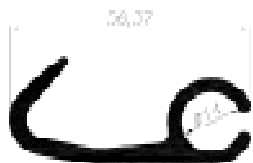

Perfil sujeta-lonas normal (16173)
005 010 01400 (L=5,5 m)
005 020 0638 (L=6 m)

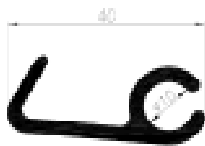

Gancho cortina trasera (14835)
005 010 0666 (L=5 m)



Perfil sujeta-lonas lateral inclinado (14490)
005 010 0667 (L=5,5 m)
005 010 0778 (L=6 m)



Tubo tensor de lona (21155)
005 010 01054 (L=4 m)
005 010 01055 (L=5 m)

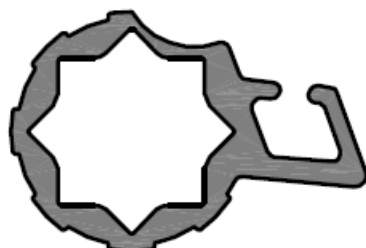

Tubo tensor de lona reforzado (14836)
005 010 0664 (L=5 m)

PERFILES PARA PROTECCION LATERAL

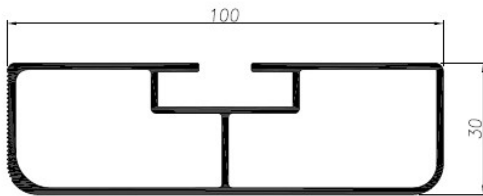

Perfil rectangular anti-empotramiento (20291)

100 x 30 mm

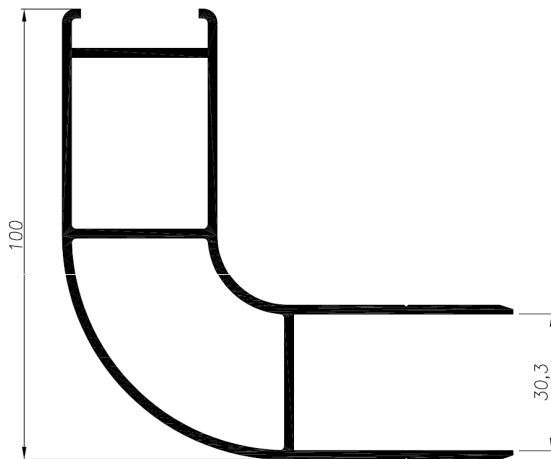
005 020 05319 (L = 3,5 m)**005 020 00773** (L = 4,5 m)**005 020 05634** (L = 6 m)

Perfil cantonera anti-empotramiento (15686)

100 x 30 mm

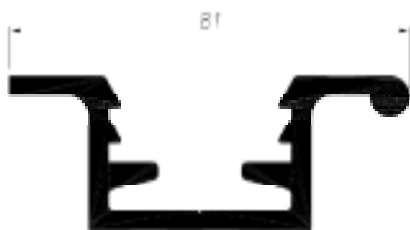
005 020 0733 (L = 6,1 m)**005 020 2418** (L = 0,5 m)

Perfil de banda exterior de dos alas (18467)

005 010 0701 (L = 6,45 m)